

# EQUIPMENT CATALOGUE



# 2024

**ESTABLISHED IN LOS ANGELES IN 2005, BODYKORE HAS EMERGED AS A PREMIER INNOVATOR IN COMMERCIAL FITNESS EQUIPMENT GLOBALLY. EXPANDING FROM OUR ROOTS, WE NOW PROUDLY OFFER FULL-SERVICE FITNESS SOLUTIONS IN THE USA, CANADA, AND TAIWAN.**

BodyKore's mission is to lead the fitness industry with cutting-edge commercial equipment, innovative design, and exceptional service. We are committed to producing superior quality products that support individual fitness goals, ensuring a rewarding customer experience. Our dedication extends beyond physical health, promoting a lifestyle that nurtures both physical and mental well-being.

## OUR VISION

**INNOVATE  
ADVANCE  
PROGRESS**

## OUR MISSION

At BodyKore, innovation and design start with a spark of an idea and persist until fully realized. Our expert team, combined with top-tier production capabilities, enables us to craft equipment of the highest biomechanical standards.

Prioritizing customer value, we engage in direct, solution-focused interactions. Our mission transcends providing quality equipment and excellent service; we actively connect with our community through online platforms and social networks. This engagement allows us to stay attuned to industry trends and customer needs, ensuring we deliver the ultimate fitness experience.

Our commitment to the fitness industry is fueled by hard work and a passion for fitness, driving us to consistently deliver excellence in all aspects of our service.

**BODYKORE**

Moving Fitness Forward

**WE'RE COMMITTED TO PROVIDING AN UNMATCHED FITNESS EXPERIENCE, BLENDING INDUSTRY EXPERTISE WITH DEDICATION AND A PASSION FOR FITNESS.**

**OUR GLOBAL LEADERSHIP IN PREMIUM FITNESS EQUIPMENT IS REFLECTED IN OUR TOP-QUALITY PRODUCTS AND EXPERT TEAM.**

## OUR SERVICES

BodyKore offers a comprehensive turn-key solution for health and fitness needs. Our dynamic team, including professional representatives and enthusiastic team members, provides everything required for your health club or gym's success. This includes specialized interior designers, fitness consultants/trainers, and cutting-edge equipment, saving you both time and money.

### EXPERT CONSULTATION

With over 30 years of combined experience in health clubs, our team is equipped to facilitate your business's success, providing essential tools and insights.

### INTERIOR DESIGN

In partnership with the award-winning design firm Interature Ltd, we create industry-leading wellness facility designs. Our focus is on maximizing space efficiency while creating a stylish and vibrant environment to enhance user experience.

### LAYOUT DESIGN

Our skilled designers use advanced 3D technology for efficient, immersive floor plans, ensuring precise, user-centric visualization and customization.

### TURN KEY SOLUTION

Leveraging our expertise and knowledge, we offer clients a complete package from start to finish. Selecting the right mix of equipment for your wellness center is crucial for maximizing utilization and ensuring member satisfaction.

**BODYKORE'S JOURNEY FROM CONCEPT TO REALITY IS DRIVEN BY OUR EXPERT TEAM AND ADVANCED MANUFACTURING EXPERTISE, ENSURING EQUIPMENT OF THE HIGHEST BIOMECHANICAL STANDARDS.**

# TABLE OF CONTENTS

## PERFORMANCE TECHNOLOGIES

6

## ISOLATION SERIES

12

SINGLE MOVEMENTS  
DUAL MOVEMENTS

16  
34

## SIGNATURE SERIES

48

BENCHES	52	SQUAT CAGES	70
DUMBBELL RACKS	60	CALF RAISE/ LEG PRESS	74
BENCH PRESSES	66		75

## ELITE SERIES

76

BENCHES	78	BENCH PRESS	91
CHIN/DIP	85	PREACHER CURL/ROW	88

## FOUNDATION SERIES

98

SQUAT CAGES 102

## ALLIANCE SERIES

104

MULTI-STATION 108  
CABLE CROSS 110

## UNIVERSAL SERIES

118

UNIVERSAL TRAINER 118  
DYNAMIC TRAINER 124  
UNIVERSAL BENCH 129

## STACKED SERIES

130

CHEST PRESS	134	SUPER SQUAT	145
LAT PULLS	139	BELT SQUAT	148

## LINX RACK

152

FULL LINX RACK SYSTEM 158

## SMART SLED

160

SMART SLED PRO 162

## INDEX

164



# PERFORMANCE TECHNOLOGIES

PROPRIETARY METATECH



**Easy Assembly**  
Each package includes up-to-date assembly and installation instructions, guaranteeing that equipment is assembled efficiently and to the highest standard.



**Precision Cut Selectorized Weights**  
Engineered for optimal performance, each weight is precision-cut, ensuring a refined appearance and purposeful design for maximum efficiency in use.



**Water Resistant Upholstery**  
Featuring water-resistant upholstery that prevents water ingress, significantly extending the lifespan and durability of our equipment.



**LB Guide Rod System**  
Enhances load capacity and smooth operation with minimal stiffness and friction, enhancing our equipment's durability and performance.



**CB Smith Machine**  
Expertly designed for enhanced stability and control, this counter balanced unit enables diverse workouts targeting various muscle groups.



**Streamlined Adjustable Pulley System**  
Engineered for the smoothest weight lifting experience, this system offers seamless adjustability and fluid movement.



**Rolled Steel Oval Tubing**  
Corrosion resistant, and stainless material designed to maximize lifespan and durability.



**Proprietary Attachment System**  
Our unique system supports various attachments, enabling personal modifications to tailor each piece of equipment to your specific needs.



**Industrial Galvanized Steel Cables**  
Our cables are strong, durable, corrosion-resistant, and heat-resistant, ensuring utmost safety and reliability in all our machines.



**Ultra Stainless Steel Fastener**  
Sturdy and durable, designed for effortless setup, adjustment, and mobility, ensuring seamless use without any complications.

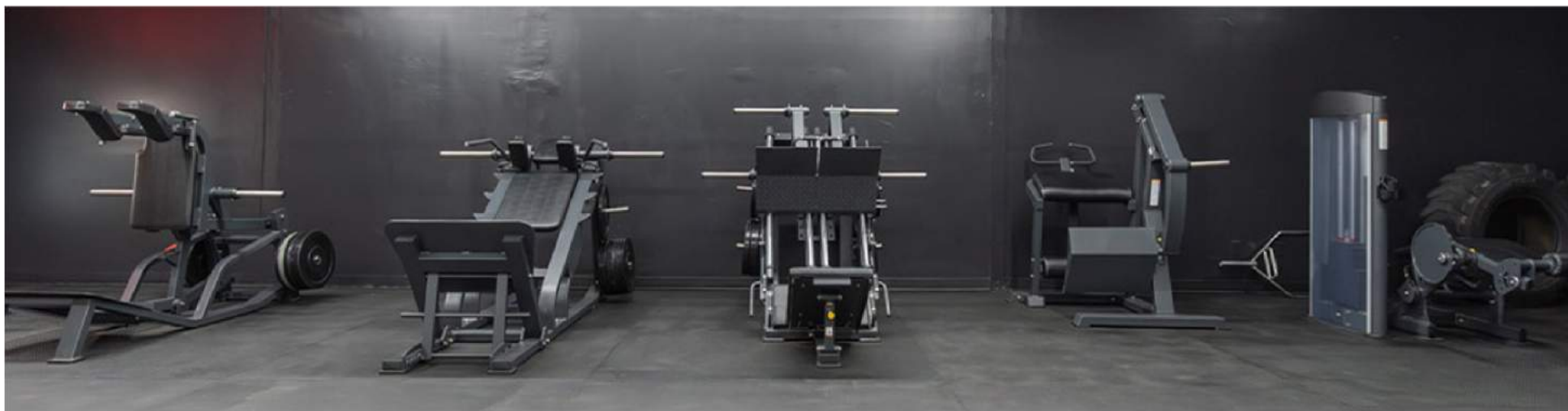

**WORK FITNESS CENTER**  
**FULLERTON, CA**



**ARRIVE RESIDENCIES**  
**RESIDENT GYM INSTALLATION**

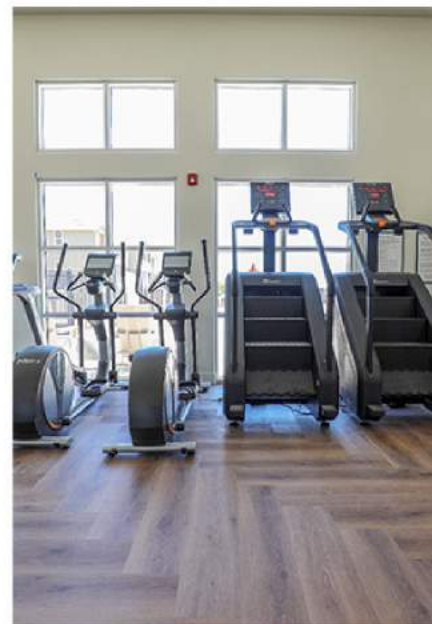

# ISOLATION

## *SELECTORIZED STRENGTH*

The Isolation Series stands out with its elegant design, achieved through meticulous precision and attention to detail. Each piece is crafted in harmony with human body mechanics and kinematics, ensuring a modern and ergonomic design.

Distinct from free weight exercises, the Isolation Series provides defined mechanics for each exercise. Its fluid motion ensures a guided path for smooth repetitions. The design is intuitively natural, allowing users to swiftly and safely transition between different Isolation machines, ideal for circuit training. The user-friendly weight adjustment system facilitates quick changes, making it perfect for drop sets and pyramid training.





A start-to-finish diagram simplifies the workout process, ensuring users of all experience levels can quickly learn and complete each exercise correctly.



The sleek black weight stack, with a maximum capacity of 220lbs, facilitates easy adjustments through pin selection, whether standing or seated.



Machine settings can be effortlessly adjusted to the user's body type using the convenient chrome push pin, providing a personalized workout experience.



Elegantly designed enclosed shields on Isolation machines prioritize safety without compromising aesthetics.



Enhanced stability during workouts is achieved with the adjustable foam roller, crafted from durable, high-strength density foam.



Cushioned seats, designed with wear impact-resistant vinyl and high-strength density foam, ensure the utmost comfort during fitness routines.



Various grips are designed with durable urethane composite, reducing stress on contact points and enhancing comfort and grip reliability.



Isolation machines offer convenient water bottle holders that double as versatile storage for phone, keys, wallet, and other personal items.

CHEST PRESS **GR601**

## UTILIZED PERFORMANCE TECHNOLOGY:



Dimension(LxWxH): **60"x50"x65"**  
Weight: **452lbs**

Weight stack standard: **220lbs**  
Workout muscles: **Pectoralis**

LAT PULL DOWN **GR602**

## UTILIZED PERFORMANCE TECHNOLOGY:



Dimension(LxWxH): **63"x59"x75"**  
Weight: **483lbs**

Weight stack standard: **220lbs**  
Workout muscles: **Latissimus dorsi, trapezius**

SEATED ROW **GR603**

## UTILIZED PERFORMANCE TECHNOLOGY:



Dimension(LxWxH): **63"x43"x65"**  
Weight: **434lbs**

Weight stack standard: **220lbs**  
Workout muscles: **Latissimus dorsi, trapezius, biceps**

SHOULDER PRESS **GR604**

## UTILIZED PERFORMANCE TECHNOLOGY:



Dimension(LxWxH): **66"x59"x65"**  
Weight: **474lbs**

Weight stack standard: **220lbs**  
Workout muscles: **Deltoid, pectoralis major, trapezius**

## LATERAL RAISE GR605



### UTILIZED PERFORMANCE TECHNOLOGY:



Dimension(LxWxH): **46"x47"x65"**  
Weight: **463lbs**

Weight stack standard: **220lbs**  
Workout muscles: **Deltoid, trapezius**

## LEG EXTENSION GR606



### UTILIZED PERFORMANCE TECHNOLOGY:



Dimension(LxWxH): **62"x49"x65"**  
Weight: **487lbs**

Weight stack standard: **220lbs**  
Workout muscles: **Quadriceps**

## SEATED LEG CURL GR607



### UTILIZED PERFORMANCE TECHNOLOGY:



Dimension(LxWxH): **69"x49"x65"**  
Weight: **522lbs**

Weight stack standard: **220lbs**  
Workout muscles: **Hamstrings**

## PRONE LEG CURL GR608



### UTILIZED PERFORMANCE TECHNOLOGY:



Dimension(LxWxH): **60"x46"x65"**  
Weight: **463lbs**

Weight stack standard: **220lbs**  
Workout muscles: **Hamstrings**

## BICEPS CURL GR609



### UTILIZED PERFORMANCE TECHNOLOGY:



Dimension(LxWxH): **45"x47"x65**  
Weight: **423lbs**

Weight stack standard: **220lbs**  
Workout muscles: **Biceps**

## TRICEPS EXTENSION GR610



### UTILIZED PERFORMANCE TECHNOLOGY:



Dimension(LxWxH): **60"x46"x65"**  
Weight: **463lbs**

Weight stack standard: **220lbs**  
Workout muscles: **Triceps**

## ABDOMINAL GR611



### UTILIZED PERFORMANCE TECHNOLOGY:



Dimension(LxWxH): **46"x45"x65**  
Weight: **445lbs**

Weight stack standard: **220lbs**  
Workout muscles: **Rectus abdominis, obliques**

## BACK EXTENSION GR612



### UTILIZED PERFORMANCE TECHNOLOGY:



Dimension(LxWxH): **47"x45"x65"**  
Weight: **445lbs**

Weight stack standard: **220lbs**  
Workout muscles: **Triceps**

## CALF EXTENSION GR613



### UTILIZED PERFORMANCE TECHNOLOGY:



Dimension(LxWxH): **47"x43"x68"**  
Weight: **414lbs**

Weight stack standard: **220lbs**  
Workout muscles: **Peroneus longus, gastrocnemius**

## SEATED LEG PRESS GR614



### UTILIZED PERFORMANCE TECHNOLOGY:



Dimension(LxWxH): **70"x43"x73"**  
Weight: **604lbs**

Weight stack standard: **220lbs**  
Workout muscles: **Gluteus maximus, Quadriceps, Hamstrings**

## LOW PULL GR616



### UTILIZED PERFORMANCE TECHNOLOGY:



Dimension(LxWxH): **67"x43"x73"**  
Weight: **425lbs**

Weight stack standard: **220lbs**  
Workout muscles: **Latissimus dorsi, trapezius, biceps**

## ROTORY TORSO GR617



### UTILIZED PERFORMANCE TECHNOLOGY:



Dimension(LxWxH): **46"x43"x65"**  
Weight: **450lbs**

Weight stack standard: **220lbs**  
Workout muscles: **External oblique, internal oblique**

## REAR KICK GR618



### UTILIZED PERFORMANCE TECHNOLOGY:



Dimension(LxWxH): **67"x43"x73"**  
Weight: **465lbs**

Weight stack standard: **220lbs**  
Workout muscles: **Gluteus maximus**

## CABLE LAT PULLDOWN GR619



### UTILIZED PERFORMANCE TECHNOLOGY:



Dimension(LxWxH): **47"x47"x88"**  
Weight: **403lbs**

Weight stack standard: **220lbs**  
Workout muscles: **Latissimus dorsi**

## PECTRORAL FLY GR620



### UTILIZED PERFORMANCE TECHNOLOGY:



Dimension(LxWxH): **64"x46"x77"**  
Weight: **478lbs**

Weight stack standard: **220lbs**  
Workout muscles: **Pectoral**

## DUAL AXIS CHEST PRESS GR621



### UTILIZED PERFORMANCE TECHNOLOGY:



Dimension(LxWxH): **61"x49"x71"**  
Weight: **460lbs**

Weight stack standard: **220lbs**  
Workout muscles: **Pectoral, Triceps**

## SELECTORIZED HIP THRUST GR624



### UTILIZED PERFORMANCE TECHNOLOGY:



Dimension(LxWxH): **67"x41"x65"**  
Weight: **527lbs**

Weight stack standard: **220lbs**  
Workout muscles: **Gluteus Maximus**

## LEG PRESS/CALF EXTENSION GR631



### UTILIZED PERFORMANCE TECHNOLOGY:



Dimension(LxWxH): **47"x47"x88"**  
Weight: **527lbs**

Weight stack standard: **220lbs**  
Workout muscles: **Quadriceps, Peroneus longus, gastrocnemius**

## HIP ABDUCTOR/ADDUCTOR GR632



### UTILIZED PERFORMANCE TECHNOLOGY:



Dimension(LxWxH): **70"x35"x65"**  
Weight: **489lbs**

Weight stack standard: **220lbs**  
Workout muscles: **Quadriceps femoris, Adductors**

## PECTORAL FLY/BACK EXTENSION GR633



### UTILIZED PERFORMANCE TECHNOLOGY:



Dimension(LxWxH): **57"x56"x77"**  
Weight: **465lbs**

Weight stack standard: **220lbs**  
Workout muscles: **Pectoral major, trapezius**

## BICEPS CURL/TRICEPS EXTENSION GR634



### UTILIZED PERFORMANCE TECHNOLOGY:



Dimension(LxWxH): **47"x48"x65"**  
Weight: **459lbs**

Weight stack standard: **220lbs**  
Workout muscles: **Biceps, Triceps**

## ROTARY HIP GR635

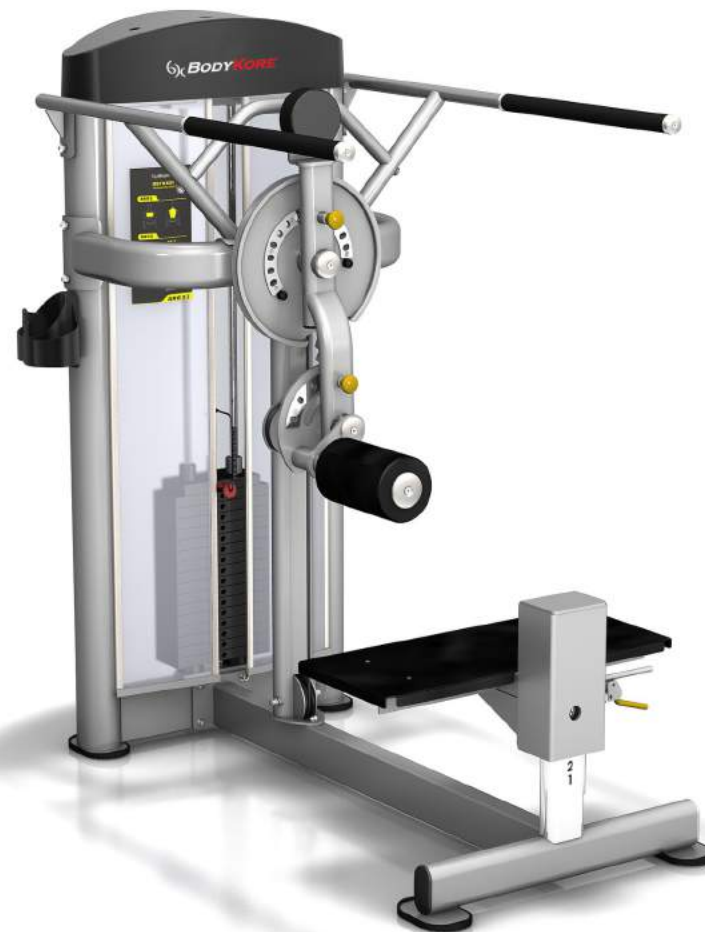

### UTILIZED PERFORMANCE TECHNOLOGY:



Dimension(LxWxH): **57"x56"x77"**  
Weight: **465lbs**

Weight stack standard: **220lbs**  
Workout muscles: **Adductors**

## DIP/CHIN ASSIST GR636



### UTILIZED PERFORMANCE TECHNOLOGY:



Dimension(LxWxH): **55"x49"x94"** Workout muscles: **Pectoralis, Macrotriceps, Biceps, Trapezius, Latissimus dorsi**  
 Weight: **540lbs**  
 Weight stack standard: **220lbs**

## ABDOMINAL/BACK EXTENSION GR637



### UTILIZED PERFORMANCE TECHNOLOGY:



Dimension(LxWxH): **49"x46"x65"** Weight stack standard: **220lbs**  
 Weight: **440lbs** Workout muscles: **Erector spinae, Rectus abdominis, obliques**

## LAT PULLDOWN/SEATED ROW GR638



### UTILIZED PERFORMANCE TECHNOLOGY:



Dimension(LxWxH): **77"x47"x89"** Weight stack standard: **220lbs**  
 Weight: **450lbs** Workout muscles: **Pectoralis, Latissimus dorsi**

## LEG EXTENSION/LEG CURL GR639



### UTILIZED PERFORMANCE TECHNOLOGY:



Dimension(LxWxH): **68"x50"x65"** Weight stack standard: **220lbs**  
 Weight: **522lbs** Workout muscles: **Quadriceps, Hamstrings**

## CHEST & SHOULDER PRESS GR640



### UTILIZED PERFORMANCE TECHNOLOGY:



Dimension(LxWxH): **77"x51"x65"** Weight stack standard: **220lbs**  
 Weight: **472lbs** Workout muscles: **Pectoralis, Deltoids, Trapezius**

## LEG EXTENSION/LEG PRONE GR643



### UTILIZED PERFORMANCE TECHNOLOGY:



Dimension(LxWxH): **68"x50"x65"** Weight stack standard: **220lbs**  
 Weight: **545lbs** Workout muscles: **Hamstrings, Quadriceps**

# SIGNATURE

## POWER AND STRENGTH

The Signature Series seamlessly blends classic movements with modern design, establishing it as a core feature in any wellness center. This series is the epitome of aesthetic allure paired with essential design, offering a compelling invitation for regular use. By revisiting the roots of strength training, the Signature Series surpasses basic weight training benchmarks with its exceptional quality in dumbbells, smith machines, and body weight training solutions.

Our top-of-the-line adjustable benches are designed for versatility, allowing precise angle adjustments to target specific upper body muscles effectively. The Signature Series' vibrant appearance, high gloss, and moisture-resistant qualities derive from our advanced thermosetting electrostatic powder coating process, enhancing both its visual appeal and durability.



**Ultimate Comfort Cushion Seats:** Crafted with high-strength, impact-resistant leather and dense foam, our cushion seats offer unparalleled comfort and durability.



**Space-Saving Adjustable Benches:** Our benches feature a simple pin lock system, allowing adjustments from 180 to 90 degrees and various angles in between, designed for both versatility and space efficiency.



**Stable and Mobile Design:** Equipped with rubber footings and wheels, the Signature Series ensures stability during use and easy mobility for convenient storage.



**Integrated Handles for Easy Maneuverability:** The benches include integrated handles, facilitating effortless repositioning within the wellness center.

## FLAT BENCH G201



### UTILIZED PERFORMANCE TECHNOLOGY:



Dimension(LxWxH):  
Weight:

**54"x24"x17"**  
**66lbs**

## UTILITY BENCH G202



### UTILIZED PERFORMANCE TECHNOLOGY:



Dimension(LxWxH):  
Weight:

**54"x24"x43"**  
**77lbs**

## ADJUSTABLE DECLINE BENCH G205



### UTILIZED PERFORMANCE TECHNOLOGY:



Dimension(LxWxH):  
Weight:

**61"x23"x31"**  
**95lbs**

## MULTI ADJUSTABLE BENCH G206



### UTILIZED PERFORMANCE TECHNOLOGY:



Dimension(LxWxH):  
Weight:

**54"x24"x17"**  
**106lbs**

## AB BENCH G208



### UTILIZED PERFORMANCE TECHNOLOGY:



Dimension(LxWxH):  
Weight:

**61"x36"x37"**  
**137lbs**

## STRETCH G209



### UTILIZED PERFORMANCE TECHNOLOGY:



Dimension(LxWxH):  
Weight:

**52"x21"x39"**  
**84lbs**

## PRONE BENCH G214



### UTILIZED PERFORMANCE TECHNOLOGY:



Dimension(LxWxH):  
Weight:

27"x48"x37"  
70lbs

## SISSY SQUAT FL1213



### UTILIZED PERFORMANCE TECHNOLOGY:



Dimension(LxWxH):  
Weight:

38"x24"x20"  
58lbs

## DUMBBELL RACK G231



### UTILIZED PERFORMANCE TECHNOLOGY:



Dimension(LxWxH):  
Weight:

**90"x25"x33"**  
**143lbs**

## A FRAME DUMBBELL RACK G233



### UTILIZED PERFORMANCE TECHNOLOGY:



Dimension(LxWxH):  
Weight:

**32"x15"x45"**  
**46lbs**

## OLYMPIC WEIGHT TREES **G234**



### UTILIZED PERFORMANCE TECHNOLOGY:



Dimension(LxWxH):  
Weight:

**30"x26"x51"**  
**62lbs**

## BPRO BARBELL RACK **G236**



### UTILIZED PERFORMANCE TECHNOLOGY:



Dimension(LxWxH):  
Weight:

**35"x33"x49"**  
**80lbs**

## BODYKORE DUMBBELL RACK FITS 5-50LBS **G241**



## BODYKORE DUMBBELL RACK FITS 5-75LBS **G242**



## BODYKORE DUMBBELL RACK FITS 5-100LBS **G243**



### UTILIZED PERFORMANCE TECHNOLOGY:



#### BodyKore Dumbbell Rack Fits 5-50lb **G241**

Dimension(LxWxH): **52"x20"x35"**  
Weight: **95lbs**

#### BodyKore Dumbbell Rack Fits 5-75lb **G242**

Dimension(LxWxH): **67"x21"x36"**  
Weight: **115lbs**

#### BodyKore Dumbbell Rack Fits 5-100lb **G243**

Dimension(LxWxH): **95"x21"x36"**  
Weight: **135lbs**

## OLYMPIC BENCH PRESS G251



### UTILIZED PERFORMANCE TECHNOLOGY:



Dimension(LxWxH):  
Weight:

**67"x71"x89"**  
**179lbs**

## OLYMPIC INCLINE PRESS G252



### UTILIZED PERFORMANCE TECHNOLOGY:



Dimension(LxWxH):  
Weight:

**72"x66"x61"**  
**203lbs**

## OLYMPIC DECLINE PRESS G253



### UTILIZED PERFORMANCE TECHNOLOGY:



Dimension(LxWxH):  
Weight:

**81"x67"x53"**  
**200lbs**

## MILITARY PRESS G254



### UTILIZED PERFORMANCE TECHNOLOGY:



Dimension(LxWxH):  
Weight:

**69"x65"x70"**  
**278lbs**

## OLYMPIC SQUAT RACKS **G255**



### UTILIZED PERFORMANCE TECHNOLOGY:



Dimension(LxWxH):  
Weight:

**67"x61"x74"**  
**254lbs**

## POWER CAGE **G256**



### UTILIZED PERFORMANCE TECHNOLOGY:



Dimension(LxWxH):  
Weight:

**69"x69"x90"**  
**357lbs**

## PREACHER CURL G257



### UTILIZED PERFORMANCE TECHNOLOGY:



Dimension(LxWxH):  
Weight:

**41"x34"x42"**  
**99lbs**

## OLYMPIC SMITH MACHINE G271



### UTILIZED PERFORMANCE TECHNOLOGY:



Dimension(LxWxH):  
Weight:

**94"x52"x94"**  
**421lbs**

## T BAR ROW **G273**



### UTILIZED PERFORMANCE TECHNOLOGY:



Dimension(LxWxH):  
Weight:

**61"x30"x25"**  
**126lbs**

## 45 DEGREE LEG PRESS **G277**



### UTILIZED PERFORMANCE TECHNOLOGY:



Dimension(LxWxH):  
Weight:  
Max Load:

**83"x64"x52"**  
**424lbs**  
**882lbs**



# ELITE

## *QUALITY AND ELEGANCE*

The Elite Series sets a new standard in fitness equipment design, combining state-of-the-art functionality with unmatched aesthetic appeal. Its sleek curves and high-quality finish transform any space it occupies. Building upon the foundation of our Signature line, the Elite Series introduces enhanced stylistic elements and superior hardware.

Manufactured from top-grade steel and backed by a lifetime warranty, the Elite Series exemplifies durability and sophistication. Unique features such as urethane mounting hooks, rubber step padding, stainless steel nuts and bolts, and extended mounting plates distinguish the Elite Series as a truly exceptional range of fitness equipment.

## FLAT BENCH CF2101



### UTILIZED PERFORMANCE TECHNOLOGY:



Dimension(LxWxH):  
Weight:

**56"x26"x19"**  
**64lbs**

## UTILITY BENCH CF2102



### UTILIZED PERFORMANCE TECHNOLOGY:



Dimension(LxWxH):  
Weight:

**51"x33"x39"**  
**86lbs**

## MUTLI-AB BENCH CF2103



### UTILIZED PERFORMANCE TECHNOLOGY:



Dimension(LxWxH):  
Weight:

53"x33"x44"  
106lbs

## HYPEREXTENSION CF2104



### UTILIZED PERFORMANCE TECHNOLOGY:



Dimension(LxWxH):  
Weight:

49"x33"x31"  
121lbs

## ADJUSTABLE DECLINE BENCH CF2105



### UTILIZED PERFORMANCE TECHNOLOGY:



Dimension(LxWxH):  
Weight:

61"x33"x20"  
99lbs

## MULTI ADJUSTABLE BENCH CF2106



### UTILIZED PERFORMANCE TECHNOLOGY:



Dimension(LxWxH):  
Weight:

54"x24"x17"  
99lbs

## VERTICAL KNEE RAISE **CF2107**



### UTILIZED PERFORMANCE TECHNOLOGY:



Dimension(LxWxH):  
Weight:

**49"x31"x64"**  
**187lbs**

## CHIN/DIP **CF2110**



### UTILIZED PERFORMANCE TECHNOLOGY:



Dimension(LxWxH):  
Weight:

**49"x50"x88"**  
**238lbs**

## WEIGHT PLATE TREE **CF2134**



### UTILIZED PERFORMANCE TECHNOLOGY:



Dimension(LxWxH):  
Weight:

**51"x51"x50"**  
**148lbs**

## BARBELL RACK **CF2136**



### UTILIZED PERFORMANCE TECHNOLOGY:



Dimension(LxWxH):  
Weight:

**35"x35"x53"**  
**165lbs**

## OLYMPIC BENCH PRESS CF2151



### UTILIZED PERFORMANCE TECHNOLOGY:



Dimension(LxWxH):  
Weight:

56"x51"x52"  
130lbs

## OLYMPIC INCLINE PRESS CF2152



### UTILIZED PERFORMANCE TECHNOLOGY:



Dimension(LxWxH):  
Weight:

72"x66"x61"  
203lbs

## OLYMPIC DECLINE PRESS CF2153



### UTILIZED PERFORMANCE TECHNOLOGY:



Dimension(LxWxH):  
Weight:

80"x67"x53"  
201lbs

## SEATED PREACHER CURL CF2157



### UTILIZED PERFORMANCE TECHNOLOGY:



Dimension(LxWxH):  
Weight:

50"x33"x39"  
106lbs

## LUNGE RACK CF2159



### UTILIZED PERFORMANCE TECHNOLOGY:



Dimension(LxWxH):  
Weight:

**68"x67"x77"**  
**289lbs**

## STANDING BICEPS CF2160



### UTILIZED PERFORMANCE TECHNOLOGY:



Dimension(LxWxH):  
Weight:

**47"x33"x41"**  
**132lbs**

# SMITH MACHINE CF2171



**UTILIZED PERFORMANCE TECHNOLOGY:**



Dimension(LxWxH): **93"x32"x89"**  
 Weight: **448lbs**

# SEATED CALF RAISE CF2172



**UTILIZED PERFORMANCE TECHNOLOGY:**



Dimension(LxWxH): **51"x33"x36"**  
 Weight: **112lbs**

## STANDING ROW CF2173



### UTILIZED PERFORMANCE TECHNOLOGY:



Dimension(LxWxH):  
Weight:

61"x35"x47"  
112lbs

## HACK SQUAT CF2175



### UTILIZED PERFORMANCE TECHNOLOGY:



Dimension(LxWxH):  
Weight:

81"x64"x55"  
470lbs

# FOUNDATION

## *ATHLETICS AND WEIGHTLIFTING*

Raising the bar for functionality and dynamics, the Foundation Series connects Olympic style weightlifting with modern design. This series includes robust racks that serve as the cornerstone of power and strength training.

Designed for the seasoned lifter, the Foundation Series features a variety of cages, each promoting industrial-grade ergonomics and a free range of motion for safe, powerful workouts. It brilliantly balances strength and intelligence with its highly versatile designs aimed at maximizing workout efficiency. Enhanced stability is ensured by reinforced connecting plates, while the sleek black powder coating and stainless steel bolts maintain the series' polished look.





**Precision-Engineered Spotter Arms and J-Hook Placements:** Features laser-cut spotter arms and J-hooks with numbered settings for enhanced precision and safety.



**Stable Plate and Bar Storage:** Designed for both stability and correct form, offering a secure and organized way to store weights and bars.



**Multi-Grip Pull-Up Bars:** Constructed with  $\Phi 4.8\text{mm}$  steel, these bars boast a 12000N breaking strength and have surpassed a fatigue test of 100 million repetitions, ensuring unmatched durability and reliability.

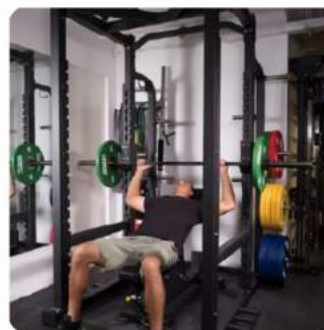

**Heavy-Duty Steel Tubing for Powerlifting:** Crafted from high-quality steel, this tubing is ideal for powerlifting and athletic programs, featuring a robust build and equipped with a self-priming pin for added convenience and safety.

## MILITARY HALF RACK G701



### UTILIZED PERFORMANCE TECHNOLOGY:



Dimension(LxWxH):  
Weight:

**53"x64"x93"**  
**440lbs**

## MILITARY FULL RACK G703



### UTILIZED PERFORMANCE TECHNOLOGY:



Dimension(LxWxH):  
Weight:

**65"x57"x90"**  
**506lbs**

3"x3" Steel Tubing, Bar pegs, land mine, J hook,  
Band hooks. included.



# ALLIANCE

*MULTI-FUNCTION CABLE SYSTEMS*

The Alliance Series merges ingenious design with versatile capabilities, perfectly aligning with the biomechanics needed in any wellness facility. This series embodies the essence of a fully-equipped fitness center while minimizing space usage typically associated with large, bulky equipment. By optimizing the spatial footprint, Alliance emphasizes both space efficiency and multifunctionality.

With its aesthetically pleasing and contemporary design, the Alliance Series fosters an inviting, social atmosphere. It encourages interaction among gym members, whether in group classes or paired exercises, as they pursue their individual fitness objectives.



Multipurpose stack weight system is smooth and soundless as uses engage simultaneously.



Two large non-slip foot platforms designed for stability and proper form.



Imported steel cable:  $\Phi 4.8\text{mm}$ , 12000N breaking strength, passed fatigue test of 100 million times.



25.4mm thick weight plates of high quality steel, well processed and come equipped, with self-priming pin.

# DUAL PULLEY MX1161



UTILIZED PERFORMANCE TECHNOLOGY:



Dimension(LxWxH): **67"x48"x89"**  
 Weight: **448lbs**

Weight stack standard: **170lbs\*2, optional: 220lbs**  
 Main Frame Uses: **4"x2"x0.12" oval pipes**

## MX1161 OPTIONAL ATTACHMENTS

### LAT PULL DOWN SEAT



### DIP BAR



# CABLE CROSSOVER G502



**UTILIZED PERFORMANCE TECHNOLOGY:**



Dimension(LxWxH): **167"x30"x92"** Weight stack standard: **187\*2, optional: 220lbs\*2,**  
 Weight: **529lbs** Main Frame Uses High Strength: **4"x2"x0.12" oval pipes**

# FOUR POSITIONS GM5003



**UTILIZED PERFORMANCE TECHNOLOGY:**



Dimension(LxWxH): **136"x72"x87"**  
 Weight: **728lbs**  
 Weight Stack Standard: **187lbs, optional: 220lbs**

# EIGHT POSITIONS GM5004

# FIVE POSITIONS CAGE GM5005



UTILIZED PERFORMANCE TECHNOLOGY:



UTILIZED PERFORMANCE TECHNOLOGY:



Dimension(LxWxH): 233"x180"x92"  
 Weight: 1517lbs  
 Weight Stack Standard: 187lbs\*2, optional: 220lbs\*2

Dimension(LxWxH): 204"x144"x92"  
 Weight: 1023lbs  
 Weight Stack Standard: 187lbs\*2, optional: 220lbs\*5

## 2 STATIONS MTI4001



VARIATIONS:	DIMENSIONS(LxWxH):	WEIGHT:
<b>MTI 4001A</b> (IN PHOTO) Chest/Back, Leg Extension	86"x77"x86"	430lbs
<b>MTI 4001B</b> Leg Press, Leg Extension	94"x69"x86"	498lbs
<b>MTI 4001C</b> Leg Press, Pec/Fly	94"x69"x86"	477lbs
<b>MTI 4001D</b> Chest/Back, Pec/Fly	83"x83"x86"	415lbs
<b>MTI 4001E</b> Chest/Back, Leg Press	94"x69"x86"	477lbs
<b>MTI 4001F</b> Pec/Fly, Leg Extension	94"x69"x86"	430lbs

### UTILIZED PERFORMANCE TECHNOLOGY:



Weight Stack Standard

220lbs\*2

## MULTI GYM MTI4201



### UTILIZED PERFORMANCE TECHNOLOGY:



Dimension(LxWxH):

94"x43"x86"

Weight:

360lbs

Weight Stack Standard

220lbs\*2

## 4 STATIONS MTI4009



**VARIATIONS:**

		<b>DIMENSIONS(LxWxH):</b>	<b>WEIGHT:</b>
<b>MTI 4009</b> (IN PHOTO)	Chest, Leg Extension, Leg Press, Column Pulley	105"x94"x88"	667lbs
<b>MTI 4010</b>	Chest, Leg Extension, Leg Press, Pec/Fly	105"x118"x86"	694lbs

**UTILIZED PERFORMANCE TECHNOLOGY:**



Weight Stack Standard

**220lbs\*4**

## 5 STATIONS MTI4016



**UTILIZED PERFORMANCE TECHNOLOGY:**



Dimension(LxWxH):  
Weight:  
Weight Stack Standard

**105"x222"x90"**  
**815lbs**  
**220lbs\*5**



# UNIVERSAL TRAINER

*ALL-IN-ONE TRAINING SYSTEM*

The Universal Trainer, true to its name, is an all-encompassing training system. This versatile equipment redefines traditional fitness machinery by adding a natural feel that complements the body's movement.

With its space-efficient design, the Universal Trainer consolidates multiple exercise machines into one comprehensive unit. It accommodates a variety of workout styles, from free weights and cable resistance training to bodyweight exercises and heavy leg presses. This unique machine stands as the singular, essential equipment piece for any fitness facility or home gym, offering an unparalleled range of exercise possibilities in a single, streamlined package.



**Endless Versatility:** Includes a Lat Pull Down Seat, Dip Bar attachments, and Land Mine, offering extensive exercise options.



**Dual Adjustable Pulley System:** Comes with two 220lb weight stacks and storage hooks for pulley attachments, offering varied resistance levels.



**Inverted Leg Press Add-On:** Utilizes the smith bar for innovative inverted leg presses, enhancing lower body workouts.

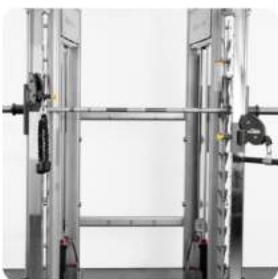

**Balanced Smith Machine Spotters:** Ensures safety with its dual balanced design, making it a secure training system.



**Premium Urethane Padded J Hooks and Spotter Arms Removable Attachments for Olympic Bars.**



**Convenient Attachment Hooks:** Six hooks for neatly storing cable attachments, keeping the workout area organized.



**Multi-Grip Pull-Up Handles:** Designed to target different areas of the back, enhancing upper body strength training.



**Precision Laser-Cut Holes and Numbers:** Ensures accuracy and ease of use, enhancing the overall workout experience.

#### ADDITIONAL ATTACHMENTS



**JAMMER ARMS MX1171**



**LEG EXTENSION/CURL MX1175**



**STORAGE RACK MX1191**



**LOW ROW FOOTPLATE MX1192**



## MULTI-FUNCTIONAL ALL-IN-ONE VERSATILE UNIT

Dual Adjustable Pulley System

Smith Machine

Multi-Grip Pull Up Bars

Half Squat Cage Function

Bar Hooks and Spotters

Lat Pull Down Seat Add-On

Leg Extension/Curl Add-On

Inverted Leg Press Add-On

Dip Bar Attachment

Accessories Storage

Weight Pegs and Bar Storage

Land Mine

Dimension(LxWxH):

**64.5"x90.3"x90.4"**

Weight:

**595lbs**

Weight Stack Standard

**220lbs\*2, optional: 220lbs\*5**

Frame Color:

**Silver and Black optional**

# DYNAMIC TRAINER

*DUAL ADJUSTABLE PULLEY SYSTEM*

The Universal Trainer's little brother, the Dynamic Trainer, comes with almost all of the same features of the Universal Trainer minus the counter balanced smith machine.

This unit is ideal for those who prefer the versatility of free weights. It includes removable J hooks and spotters, allowing it to function both as a functional trainer and a half rack. Its array of accessories and attachments adds to its versatility, making it a highly adaptable choice for diverse training needs.

**UTILIZED PERFORMANCE TECHNOLOGY:**



**BODYKORE**

Moving Fitness Forward



# MX1161EX DYNAMIC TRAINER MULTI-USE DUAL ADJUSTABLE CABLE SYSTEM

- Dual Adjustable Pulley System - 2x 220LB Weight Stacks
- Multi-Grip Pull Up Bars
- Machine Accessories Included: J Hooks, Bar Spotters, Landmine, Dip Bar, Lat Pull Down Seat
- Cable Attachments included (Handles, Rope, Lat Bar, Tricep Bar, Ankle Attachment)
- Thermosetting Electrostatic Powder Coating process enhances the equipment with vibrant colors and a glossy metallic finish, adding to its visual appeal.
- Frame made with 3.5" Oval Rolled Steel Tubing- Rated over 1000lbs
- Solid Guide Rails for smooth consistent movement
- Made with High Quality Steel Plates

## PRODUCT SPECS

- Assembled Dimensions: (LWH) 64.5"x90.3"x90.4"
- Product Weight: 595lbs
- Weight Stack: 220lbsx2
- Frame Color: Silver and Black options



# DYNAMIC TRAINER MX1161EX



**UTILIZED PERFORMANCE TECHNOLOGY:**



Dimension(LxWxH): **67"x71"x89"**  
 Weight: **595lbs**  
 Max Weight Stack: **220lbs**

# UNIVERSAL BENCH MX1169



**MX1169 OPTIONAL ATTACHMENTS**

**LEG EXTENSION**

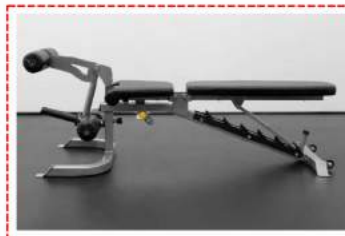

**PREACHER CURL**



**UTILIZED PERFORMANCE TECHNOLOGY:**



Dimension(LxWxH): **61"x26"x50"**  
 Weight: **80lbs**

# STACKED

## *PLATE LOADED MACHINES*

The Stacked Series ingeniously blends the free weight essence of the Foundation Series with the targeted motion of the Isolation Series. This plate-loaded lineup is designed for independent arm movements, enabling balanced muscle growth and unilateral strength training. Stacked offers a harmonious combination of power and precision, ensuring a safe and effective strength-building journey.

Showcasing top-tier craftsmanship, the series features precise aluminum alloy end caps, visually appealing cushion designs, and a sleek glossy finish. Its robust construction supports heavy weightlifting, complemented by non-slip grip handles for secure and comfortable training, even under significant loads.



**Ergonomic Non-Slip Handles:** Designed to prevent hand slippage under heavy loads, enhancing grip strength. Each handle is complemented with high-precision aluminum alloy end caps, showcasing its superior quality.



**Refined Craftsmanship:** Each piece features precise aluminum alloy end caps, elegant bolts, and a smooth glossy finish, highlighting the series' attention to detail and quality.



**Uniform Seat Height Adjustment:** Allows users to easily find and set their preferred seat height across all Stacked Series machines, ensuring a consistent workout experience.



**Comfort-Focused Cushions:** Crafted from high-density polymeric sponge, these cushions conform to the human body, providing both stability and comfort during intense workouts.

## CHESS PRESS GR801



### UTILIZED PERFORMANCE TECHNOLOGY:



Dimension(LxWxH): **51"x65"x67"**  
 Weight: **364lbs**  
 Max Weight Stack: **220lbs**

## SEATED ROW GR802



### UTILIZED PERFORMANCE TECHNOLOGY:



Dimension(LxWxH): **53"x53"x51"**  
 Weight: **342lbs**  
 Max Weight Stack: **220lbs**

# SHOULDER PRESS GR803



**UTILIZED PERFORMANCE TECHNOLOGY:**



Dimension(LxWxH): **55"x59"x58"**  
 Weight: **331lbs**  
 Max Weight Stack: **220lbs**

# INCLINE CHEST PRESS GR804



**UTILIZED PERFORMANCE TECHNOLOGY:**



Dimension(LxWxH): **43"x74"x66"**  
 Weight: **342lbs**  
 Max Weight Stack: **220lbs**

## WIDE CHEST PRESS GR805



### UTILIZED PERFORMANCE TECHNOLOGY:



Dimension(LxWxH): **54"x66"x70"**  
 Weight: **375lbs**  
 Max Weight Stack: **220lbs**

## PULL DOWN GR806



### UTILIZED PERFORMANCE TECHNOLOGY:



Dimension(LxWxH): **70"x49"x77"**  
 Weight: **375lbs**  
 Max Weight Stack: **220lbs**

## LOW ROW GR807



### UTILIZED PERFORMANCE TECHNOLOGY:



Dimension(LxWxH): **51"x51"x64"**  
 Weight: **364lbs**  
 Max Weight Stack: **220lbs**

## LEG PRESS GR808



### UTILIZED PERFORMANCE TECHNOLOGY:



Dimension(LxWxH): **88"x69"x60"**  
 Weight: **441lbs**  
 Max Weight Stack: **529lbs**

## CALF GR809



### UTILIZED PERFORMANCE TECHNOLOGY:



Dimension(LxWxH): **66"x40"x45"**  
 Weight: **287lbs**  
 Max Weight Stack: **320lbs**

## REAR KICK GR810



### UTILIZED PERFORMANCE TECHNOLOGY:



Dimension(LxWxH): **53"x50"x64"**  
 Weight: **287lbs**  
 Max Weight Stack: **320lbs**

# ISOLATERAL LEG PRESS FL1801



**UTILIZED PERFORMANCE TECHNOLOGY:**



Dimension(LxWxH):  
Weight:

**87"x63"x72"**  
**783lbs**

# SUPER SQUAT FL1806



**UTILIZED PERFORMANCE TECHNOLOGY:**



Dimension(LxWxH):  
Weight:

**80"x53"x49"**  
**358lbs**

## ADJUSTABLE HACK SQUAT **FL1811**



### UTILIZED PERFORMANCE TECHNOLOGY:



Dimension(LxWxH):  
Weight:

**78"x62"x52"**  
**606lbs**

## ISOLATERAL CHEST/SHOULDER PRESS **FL1862**



### UTILIZED PERFORMANCE TECHNOLOGY:



Dimension(LxWxH):  
Weight  
Workout Muscles:

**64"x75"x76"**  
**760lbs**  
**Chest, Shoulders, Triceps**

## BELT SQUAT FL1834



### UTILIZED PERFORMANCE TECHNOLOGY:



Dimension(LxWxH):  
Weight:

**66"x67"x86"**  
**341lbs**

## HIP THRUST FL1844



### UTILIZED PERFORMANCE TECHNOLOGY:



Dimension(LxWxH):  
Weight:

**54"x54"x33"**  
**181lbs**

## PENDULUM SQUAT CF8137



### UTILIZED PERFORMANCE TECHNOLOGY:



Dimension(LxWxH):  
Weight:

**68"x34"x94"**  
**470lbs**

## GLUTE PRESS CF8138



### UTILIZED PERFORMANCE TECHNOLOGY:



Dimension(LxWxH):  
Weight:

**58"x64"x94"**  
**470lbs**

# LINX RACK

## FULL MODULAR SYSTEM

High-grade stainless-steel hardware

Electrostatic Powder Coating

16 Adjustable Points

Extended overhanging pull-up bar

Customizable headpiece

Floor or wall mounted

## SINGLE BAY VFCR1701A



Dimension(LxWxH):  
Weight:

**50"x36"x94"**  
**505lbs**

## SMITH MACHINE VFCR1701B



Dimension(LxWxH):  
Weight:

**82"x63"x95"**  
**567lbs**

## CABLE CROSSOVER **VFCR1701C**



Dimension(LxWxH):  
Weight:

**102"x42"x95"**  
**567lbs**

## DISPLAY STORAGE **VFCR1701D**



Dimension(LxWxH):  
Weight:

**102"x42"x95"**  
**1048lbs**

## FULL LYNX RACK SYSTEM **VFCR1702B**



Dimension(LxWxH):  
Weight:

**254"x63"x94"**  
**2223lbs**



# SMART SLED

## INTELLIGENT PUSH-PULL SLED

Revolutionizing traditional sled training, the Smart Sled Pro is designed for athletes seeking a comprehensive workout challenge. It activates every muscle group, enhancing power, strength, agility, and endurance. This cutting-edge sled stands out with its patented app-controlled features and live data feedback, allowing for a more analytical approach to training. It supports multi-planar movements, a range of training modes, and offers motorized resistance that surpasses conventional sleds by up to 3x's!!! The Smart Sled Pro is intelligently designed to help athletes and fitness enthusiasts train smarter and outperform those using yesterday's sled, positioning it as the most advanced sled on the market.

# SMART SLED PRO

PERMANENT MAGNETIC  
DIGITAL RESISTANT MOTORS



REMOVABLE AND  
ERGONOMIC HANDLES



CASTER WHEELS



DUAL WEIGHT PEGS

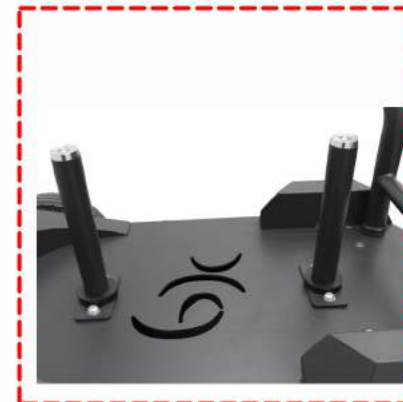

ALL TERRAIN TIRES WITH HIGH  
QUALITY ALLOY WHEELS



TOW HOOK



Dimension(LxWxH):  
Weight:  
Max Weight Stack:

**45"x40"x31"**  
**595lbs**  
**250lbs**

ISOLATION SERIES

CODE	PRODUCT NAME	PRODUCT DIMENSIONS*						PRODUCT WEIGHT		WEIGHT STACK	
		METRIC (CM)			ENGLISH (IN)			METRIC	ENGLISH	METRIC	ENGLISH
		L	W	H	L	W	H	KG	LBS	KG	LBS
GR601	CHEST PRESS	152.4	127	165.1	60	50	65	205	452	99.8	220
GR602	LAT PULL DOWN	160	149.9	190.5	63	59	75	219.1	483	99.8	220
GR603	SEATED ROW	160	109.2	165.1	63	43	65	196.9	434	99.8	220
GR604	SHOULDER PRESS	167.6	149.9	165.1	66	59	65	215	474	99.8	220
GR605	LATERAL RAISE	116.8	119.4	165.1	46	47	65	210	463	99.8	220
GR606	LEG EXTENSION	157.5	124.5	165.1	62	49	65	220.9	487	99.8	220
GR607	SEATED LEG CURL	175.3	124.5	165.1	69	49	65	236.8	522	99.8	220
GR608	PRONE LEG CURL	152.4	116.8	165.1	60	46	65	210	463	99.8	220
GR609	BICEPS CURL	114.3	119.4	165.1	45	47	65	191.9	423	99.8	220
GR610	TRICEPS EXTENSION	152.4	116.8	165.1	60	46	65	210	463	99.8	220
GR611	ABDOMINAL	116.8	114.3	165.1	46	45	65	201.8	445	99.8	220
GR612	BACK EXTENSION	119.4	114.3	165.1	47	45	65	201.8	445	99.8	220
GR613	CALF EXTENSION	119.4	109.2	172.7	47	43	68	187.8	414	99.8	220
GR614	SEATED LEG PRESS	177.8	109.2	185.4	70	43	73	274	604	99.8	220
GR616	LOW PULL	170.2	109.2	185.4	67	43	73	192.8	425	99.8	220
GR617	ROTARY TORSO	116.8	109.2	165.1	46	43	65	204.1	450	99.8	220
GR618	REAR KICK	170.2	109.2	185.4	67	43	73	211	465	99.8	220
GR619	CABLE LAT PULLDOWN	119.4	119.4	223.5	47	47	88	182.8	403	99.8	220
GR620	PECTORAL FLY	162.6	116.8	195.6	64	46	77	216.8	478	99.8	220
GR621	DUAL AXIS CHEST PRESS	155	125	181	61	49	71	209	460	99.8	220
GR624	SELECTORIZED HIP THRUST	171	105	166	67	41	65	240	527	99.8	220
GR631	LEG PRESS/ CALF EXTENSION	119.4	119.4	223.5	47	47	88	239	527	99.8	220
GR632	HIP ABDUCTOR/ ADDUCTOR	177.8	88.9	165.1	70	35	65	221.8	489	99.8	220
GR633	PECTORAL FLY/ BACK EXTENSION	144.8	142.2	195.6	57	56	77	210.9	465	99.8	220
GR634	BICEPS CURL/ TRICEPS EXTENSION	119.4	121.9	165.1	47	48	65	208.2	459	99.8	220
GR635	ROTARY HIP	144.8	142.2	195.6	57	56	77	210.9	465	99.8	220
GR636	DIP/CHIN ASSIST	139.7	124.5	238.8	55	49	94	244.9	540	99.8	220
GR637	ABDOMINAL/ BACK EXTENSION	124.5	116.8	165.1	49	46	65	199.6	440	99.8	220
GR638	LAT PULLDOWN/ SEATED ROW	195.6	119.4	226.1	77	47	89	204.1	450	99.8	220

STRENGTH WARRANTY (NORTH AMERICA ONLY)		STRENGTH WARRANTY (NORTH AMERICA ONLY)	
FRAME (NOT COATINGS)**	LIFETIME	OTHER ITEMS NOT SPECIFIED	3 YEARS
WEIGHT STACKS	10 YEARS	LABOR	3 YEARS
PULLEYS	10 YEARS	UPHOLSTERY / CABLES / SPRINGS / GRIPS	1 YEAR
PIVOT BEARINGS	10 YEARS	ACCESSORIES	6 MONTHS

\* DIMENSIONS LISTED ARE MAXIMUM IN-USE DIMENSIONS

\*\* FRAME IS DEFINED AS THE WELDED-METAL BASE OF THE UNIT AND DOES NOT INCLUDE REMOVABLE PARTS

NOT: ALL SPECIFICATIONS ARE SUBJECT TO CHANGE WITHOUT NOTICE. ACTUAL PRODUCTS MAY DIFFER FROM THOSE PICTURED IN THIS CATALOG

ISOLATION SERIES

CODE	PRODUCT NAME	PRODUCT DIMENSIONS*						PRODUCT WEIGHT		WEIGHT STACK	
		METRIC (CM)			ENGLISH (IN)			METRIC	ENGLISH	METRIC	ENGLISH
		L	W	H	L	W	H	KG	LBS	KG	LBS
GR639	LEG EXTENSION/ LEG CURL	172.7	127	165.1	68	50	65	236.8	522	99.8	220
GR640	CHEST & SHOULDER PRESS	195.6	129.5	165.1	77	51	65	214.1	472	99.8	220
GR643	LEG EXTENSION/ LEG PRONE	172.7	127	165.1	68	50	65	247	545	99.8	220

STRENGTH WARRANTY (NORTH AMERICA ONLY)		STRENGTH WARRANTY (NORTH AMERICA ONLY)	
FRAME (NOT COATINGS)**	LIFETIME	OTHER ITEMS NOT SPECIFIED	3 YEARS
WEIGHT STACKS	10 YEARS	LABOR	3 YEARS
PULLEYS	10 YEARS	UPHOLSTERY / CABLES / SPRINGS / GRIPS	1 YEAR
PIVOT BEARINGS	10 YEARS	ACCESSORIES	6 MONTHS

\* DIMENSIONS LISTED ARE MAXIMUM IN-USE DIMENSIONS

\*\* FRAME IS DEFINED AS THE WELDED-METAL BASE OF THE UNIT AND DOES NOT INCLUDE REMOVABLE PARTS

NOT: ALL SPECIFICATIONS ARE SUBJECT TO CHANGE WITHOUT NOTICE. ACTUAL PRODUCTS MAY DIFFER FROM THOSE PICTURED IN THIS CATALOG

SIGNATURE SERIES

CODE	PRODUCT NAME	PRODUCT DIMENSIONS*						PRODUCT WEIGHT		WEIGHT STACK	
		METRIC (CM)			ENGLISH (IN)			METRIC	ENGLISH	METRIC	ENGLISH
		L	W	H	L	W	H	KG	LBS	KG	LBS
G201	FLAT BENCH	138	61	44	54	24	17	30	66		
G202	UTILITY BENCH	138	61	110	54	24	43	35	77		
G203	MULTI-AB BENCH	140	59	92	55	23	36	49	106		
G204	MULTI HYPER EXTENSION BENCH	130	79	77	51	31	30	41	90		
G205	ADJUSTABLE DECLINE BENCH	155	59	79	61	23	31	44	95		
G206	MULTI ADJUSTABLE BENCH	138	61	44	54	24	17	49	106		
G207	VERTICAL KNEE RAISE	148	77	158	48	30	62	56	123		
G208	AB BENCH	155	92	94	61	36	37	63	137		
G209	STRETCH	133	54	100	52	21	39	39	84		
G214	PRONE BENCH	69	122	94	27	48	37	32	70		
FL1213	SISSY SQUAT	97	61	51	38	24	20	27	58		
G231	DUMBBELL RACK	230	64	84	90	25	33	65	143		
G232	SMALL DUMBBELL RACK	155	64	84	61	25	33	51	112		
G233	WOMEN DUMBBELL RACK	82	89	115	32	15	45	21	46		
G234	OLYMPIC WEIGHT TREES	77	67	130	30	26	51	29	62		

STRENGTH WARRANTY (NORTH AMERICA ONLY)		STRENGTH WARRANTY (NORTH AMERICA ONLY)	
FRAME (NOT COATINGS)**	LIFETIME	OTHER ITEMS NOT SPECIFIED	3 YEARS
WEIGHT STACKS	10 YEARS	LABOR	3 YEARS
PULLEYS	10 YEARS	UPHOLSTERY / CABLES / SPRINGS / GRIPS	1 YEAR
PIVOT BEARINGS	10 YEARS	ACCESSORIES	6 MONTHS

\* DIMENSIONS LISTED ARE MAXIMUM IN-USE DIMENSIONS

\*\* FRAME IS DEFINED AS THE WELDED-METAL BASE OF THE UNIT AND DOES NOT INCLUDE REMOVABLE PARTS

NOT: ALL SPECIFICATIONS ARE SUBJECT TO CHANGE WITHOUT NOTICE. ACTUAL PRODUCTS MAY DIFFER FROM THOSE PICTURED IN THIS CATALOG

SIGNATURE SERIES

CODE	PRODUCT NAME	PRODUCT DIMENSIONS*						PRODUCT WEIGHT		WEIGHT STACK	
		METRIC (CM)			ENGLISH (IN)			METRIC	ENGLISH	METRIC	ENGLISH
		L	W	H	L	W	H	KG	LBS	KG	LBS
G241	DUMBBELL RACK FITS (5-50LBS)	133	51	89	52	20	35	43	95		
G242	DUMBBELL RACK FITS (5-75LBS)	171	109.2	165.1	67	21	36	53	115		
G243	DUMBBELL RACK FITS (5-100LBS)	241.3	109.2	165.1	95	21	36	62	135		
G251	OLYMPIC BENCH PRESS	170.2	180.3	226	67	71	89	62	179		
G252	OLYMPIC INCLINE PRESS	183	167	154	72	66	61	92	203		
G253	OLYMPIC DECLINE PRESS	204	170	135	81	67	53	91	200		
G254	MILITARY PRESS	175	166	177	69	65	70	126	278		
G255	OLYMPIC SQUAT RACKS	168	170	188.5	67	61	74	116	254		
G256	POWER CAGE	170	170	228	67	67	90	162	357		
G257	PREACHER CURL	108	79	91	41	32	42	45	99		
G259	SQUAT RACK	170	162	195	67	64	77	103	227		
G271	OLYMPIC SMITH MACHINE	239	133	239	94	52	94	191	421		
G272	SEATED CALF RAISE	132	74	89	52	29	35	53	117		
G273	T BAR ROW	155	77	64	61	30	25	58	126		
G277	45 DEGREE LEG PRESS	211	163	132	83	64	52	192	424		

STRENGTH WARRANTY (NORTH AMERICA ONLY)		STRENGTH WARRANTY (NORTH AMERICA ONLY)	
FRAME (NOT COATINGS)**	LIFETIME	OTHER ITEMS NOT SPECIFIED	3 YEARS
WEIGHT STACKS	10 YEARS	LABOR	3 YEARS
PULLEYS	10 YEARS	UPHOLSTERY / CABLES / SPRINGS / GRIPS	1 YEAR
PIVOT BEARINGS	10 YEARS	ACCESSORIES	6 MONTHS

\* DIMENSIONS LISTED ARE MAXIMUM IN-USE DIMENSIONS

\*\* FRAME IS DEFINED AS THE WELDED-METAL BASE OF THE UNIT AND DOES NOT INCLUDE REMOVABLE PARTS

NOT: ALL SPECIFICATIONS ARE SUBJECT TO CHANGE WITHOUT NOTICE. ACTUAL PRODUCTS MAY DIFFER FROM THOSE PICTURED IN THIS CATALOG

ELITE SERIES

CODE	PRODUCT NAME	PRODUCT DIMENSIONS*						PRODUCT WEIGHT		WEIGHT STACK	
		METRIC (CM)			ENGLISH (IN)			METRIC	ENGLISH	METRIC	ENGLISH
		L	W	H	L	W	H	KG	LBS	KG	LBS
CF2101	FLAT BENCH	143	67	49	56	26	19	30	64		
CF2102	UTILITY BENCH	133	130	84	52	51	33	39	86		

STRENGTH WARRANTY (NORTH AMERICA ONLY)		STRENGTH WARRANTY (NORTH AMERICA ONLY)	
FRAME (NOT COATINGS)**	LIFETIME	OTHER ITEMS NOT SPECIFIED	3 YEARS
WEIGHT STACKS	10 YEARS	LABOR	3 YEARS
PULLEYS	10 YEARS	UPHOLSTERY / CABLES / SPRINGS / GRIPS	1 YEAR
PIVOT BEARINGS	10 YEARS	ACCESSORIES	6 MONTHS

\* DIMENSIONS LISTED ARE MAXIMUM IN-USE DIMENSIONS

\*\* FRAME IS DEFINED AS THE WELDED-METAL BASE OF THE UNIT AND DOES NOT INCLUDE REMOVABLE PARTS

NOT: ALL SPECIFICATIONS ARE SUBJECT TO CHANGE WITHOUT NOTICE. ACTUAL PRODUCTS MAY DIFFER FROM THOSE PICTURED IN THIS CATALOG

ELITE SERIES

CODE	PRODUCT NAME	PRODUCT DIMENSIONS*						PRODUCT WEIGHT		WEIGHT STACK	
		METRIC (CM)			ENGLISH (IN)			METRIC	ENGLISH	METRIC	ENGLISH
		L	W	H	L	W	H	KG	LBS	KG	LBS
CF2103	MULTI-AB BENCH	135	84	112	53	33	44	49	106		
CF2104	HYPEREXTENSION	125	84	79	49	33	31	55	121		
CF2106	ADJUSTABLE DECLINE BENCH	155	84	51	61	33	20	45	99		
CF2106	MULTI ADJUSTABLE BENCH	138	61	138	54	24	17	45	99		
CF2107	VERTICLE KNEE RAISE	125	79	163	49	31	64	85	187		
CF2110	CHIN/DIP	125	127	224	49	50	88	108	238		
CF2134	WEIGHT PLATE TREE	130	130	127	51	51	50	68	148		
CF2136	BARBELL RACK	89	89	135	35	35	53	75	165		
CF2151	OLYMPIC BENCH PRESS	143	130	133	56	51	52	59	130		
CF2152	OLYMPIC INCLINE PRESS	183	168	155	72	66	61	93	203		
CF2153	OLYMPIC DECLINE PRESS	204	171	135	80	67	53	92	201		
CF2157	SEATED PREACHER CURL	127	84	100	50	33	39	49	106		
CF2159	LUNGE RACK	173	171	196	68	67	77	86	289		
CF2160	STANDING BICEPS	120	84	105	47	33	41	60	132		
CF2171	SMITH MACHINE	237	82	227	93	32	89	204	448		
CF2172	SEATED CALF RAISE	130	84	92	51	33	36	51	112		
CF2173	STANDING ROW	155	89	120	61	35	47	51	112		
CF2176	HACK SQUAT	206	163	140	81	64	55	214	470		

STRENGTH WARRANTY (NORTH AMERICA ONLY)		STRENGTH WARRANTY (NORTH AMERICA ONLY)	
FRAME (NOT COATINGS)**	LIFETIME	OTHER ITEMS NOT SPECIFIED	3 YEARS
WEIGHT STACKS	10 YEARS	LABOR	3 YEARS
PULLEYS	10 YEARS	UPHOLSTERY / CABLES / SPRINGS / GRIPS	1 YEAR
PIVOT BEARINGS	10 YEARS	ACCESSORIES	6 MONTHS

\* DIMENSIONS LISTED ARE MAXIMUM IN-USE DIMENSIONS

\*\* FRAME IS DEFINED AS THE WELDED-METAL BASE OF THE UNIT AND DOES NOT INCLUDE REMOVABLE PARTS

NOT: ALL SPECIFICATIONS ARE SUBJECT TO CHANGE WITHOUT NOTICE. ACTUAL PRODUCTS MAY DIFFER FROM THOSE PICTURED IN THIS CATALOG

FOUNDATION SERIES

CODE	PRODUCT NAME	PRODUCT DIMENSIONS*						PRODUCT WEIGHT		WEIGHT STACK	
		METRIC (CM)			ENGLISH (IN)			METRIC	ENGLISH	METRIC	ENGLISH
		L	W	H	L	W	H	KG	LBS	KG	LBS
G701	MILITARY HALF RACK	135	163	237	53	64	93	200	440		
G703	MILITARY FULL RACK	166	145	229	65	57	90	230	506		

STRENGTH WARRANTY (NORTH AMERICA ONLY)		STRENGTH WARRANTY (NORTH AMERICA ONLY)	
FRAME (NOT COATINGS)**	LIFETIME	OTHER ITEMS NOT SPECIFIED	3 YEARS
WEIGHT STACKS	10 YEARS	LABOR	3 YEARS
PULLEYS	10 YEARS	UPHOLSTERY / CABLES / SPRINGS / GRIPS	1 YEAR
PIVOT BEARINGS	10 YEARS	ACCESSORIES	6 MONTHS

\* DIMENSIONS LISTED ARE MAXIMUM IN-USE DIMENSIONS

\*\* FRAME IS DEFINED AS THE WELDED-METAL BASE OF THE UNIT AND DOES NOT INCLUDE REMOVABLE PARTS

NOT: ALL SPECIFICATIONS ARE SUBJECT TO CHANGE WITHOUT NOTICE. ACTUAL PRODUCTS MAY DIFFER FROM THOSE PICTURED IN THIS CATALOG

**ALLIANCE SERIES**

CODE	PRODUCT NAME	PRODUCT DIMENSIONS*						PRODUCT WEIGHT		WEIGHT STACK	
		METRIC (CM)			ENGLISH (IN)			METRIC	ENGLISH	METRIC	ENGLISH
		L	W	H	L	W	H	KG	LBS	KG	LBS
MX1171	DUAL PULLEY	94	181	173	37	71	68	183	403	78x2	170x2
GM5003	FOUR POSITIONS	346	183	221	136	72	87	331	728	85	187
G602	CABLE CROSSOVER	425	77	234	167	30	92	183	529	85x2	187x2
<b>STRENGTH WARRANTY (NORTH AMERICA ONLY)</b>						<b>STRENGTH WARRANTY (NORTH AMERICA ONLY)</b>					
FRAME (NOT COATINGS)**		LIFETIME			OTHER ITEMS NOT SPECIFIED				3 YEARS		
WEIGHT STACKS		10 YEARS			LABOR				3 YEARS		
PULLEYS		10 YEARS			UPHOLSTERY / CABLES / SPRINGS / GRIPS				1 YEAR		
PIVOT BEARINGS		10 YEARS			ACCESSORIES				6 MONTHS		

\* DIMENSIONS LISTED ARE MAXIMUM IN-USE DIMENSIONS

\*\* FRAME IS DEFINED AS THE WELDED-METAL BASE OF THE UNIT AND DOES NOT INCLUDE REMOVABLE PARTS

NOT: ALL SPECIFICATIONS ARE SUBJECT TO CHANGE WITHOUT NOTICE. ACTUAL PRODUCTS MAY DIFFER FROM THOSE PICTURED IN THIS CATALOG

**ALLIANCE SERIES**

CODE	PRODUCT NAME	PRODUCT DIMENSIONS*						PRODUCT WEIGHT		WEIGHT STACK	
		METRIC (CM)			ENGLISH (IN)			METRIC	ENGLISH	METRIC	ENGLISH
		L	W	H	L	W	H	KG	LBS	KG	LBS
GM5004	EIGHT POSITIONS	592	458	234	233	180	92	30	1517	85x2	187x2
GM5005	FIVE POSITIONS CAGE	519	366	234	204	144	92	35	1023	85x2	187x2
MT4001	<b>2 STATIONS</b>										
MT4001A	Chest/Back, Leg Extension	219	196	219	86	77	86	196	430	99.8x2	220x2
MT4001B	Leg Press, Leg Extension	239	176	219	94	69	86	226	498	99.8x2	220x2
MT4001C	Leg Press, Pec/Fly	239	176	219	94	69	86	217	477	99.8x2	220x2
MT4001D	Chest/Back, Pec/Fly	211	211	219	83	83	86	189	415	99.8x2	220x2
MT4001E	Chest/Back, Leg Press	239	176	219	94	69	86	217	477	99.8x2	220x2
MT4001F	Pec/Fly, Leg Extension	239	176	219	94	69	86	196	430	99.8x2	220x2
MT4201	Multi Gym	239	110	219	94	43	86	164	360	99.8x2	220x2

<b>STRENGTH WARRANTY (NORTH AMERICA ONLY)</b>						<b>STRENGTH WARRANTY (NORTH AMERICA ONLY)</b>					
FRAME (NOT COATINGS)**		LIFETIME			OTHER ITEMS NOT SPECIFIED				3 YEARS		
WEIGHT STACKS		10 YEARS			LABOR				3 YEARS		
PULLEYS		10 YEARS			UPHOLSTERY / CABLES / SPRINGS / GRIPS				1 YEAR		
PIVOT BEARINGS		10 YEARS			ACCESSORIES				6 MONTHS		

\* DIMENSIONS LISTED ARE MAXIMUM IN-USE DIMENSIONS

\*\* FRAME IS DEFINED AS THE WELDED-METAL BASE OF THE UNIT AND DOES NOT INCLUDE REMOVABLE PARTS

NOT: ALL SPECIFICATIONS ARE SUBJECT TO CHANGE WITHOUT NOTICE. ACTUAL PRODUCTS MAY DIFFER FROM THOSE PICTURED IN THIS CATALOG

**UNIVERSAL TRAINER**

CODE	PRODUCT NAME	PRODUCT DIMENSIONS*						PRODUCT WEIGHT		WEIGHT STACK	
		METRIC (CM)			ENGLISH (IN)			METRIC	ENGLISH	METRIC	ENGLISH
		L	W	H	L	W	H	KG	LBS	KG	LBS
MX1161	FUNCTIONAL TRAINER	170	122	227	67	48	89	203	448	99.8	220
MX1161EX	DYNAMIC TRAINER	178	122	127	70	48	50	270	595	99.8	220
MX1171	JAMMER ARMS	105	69	21	41	27	8	37	80		
MX1175	LEG EXTENSION/CURL	56	59	79	22	23	31	28	60		
MX1191	STORAGE RACK	112	72	199	44	28	78	37	80		
MX1192	LOW ROW FOOTPLATE	58	34	21	22.5	13	8	9	18		
MX1162	UNIVERSAL TRAINER	171	181	227	71	90	89	404	890	99.8	220
MX1169	UNIVERSAL BENCH	155	67	127	61	26	50	122	270		

<b>STRENGTH WARRANTY (NORTH AMERICA ONLY)</b>						<b>STRENGTH WARRANTY (NORTH AMERICA ONLY)</b>					
FRAME (NOT COATINGS)**		LIFETIME			OTHER ITEMS NOT SPECIFIED				3 YEARS		
WEIGHT STACKS		10 YEARS			LABOR				3 YEARS		
PULLEYS		10 YEARS			UPHOLSTERY / CABLES / SPRINGS / GRIPS				1 YEAR		
PIVOT BEARINGS		10 YEARS			ACCESSORIES				6 MONTHS		

\* DIMENSIONS LISTED ARE MAXIMUM IN-USE DIMENSIONS

\*\* FRAME IS DEFINED AS THE WELDED-METAL BASE OF THE UNIT AND DOES NOT INCLUDE REMOVABLE PARTS

NOT: ALL SPECIFICATIONS ARE SUBJECT TO CHANGE WITHOUT NOTICE. ACTUAL PRODUCTS MAY DIFFER FROM THOSE PICTURED IN THIS CATALOG

**STACKED SERIES**

CODE	PRODUCT NAME	PRODUCT DIMENSIONS*						PRODUCT WEIGHT		WEIGHT STACK	
		METRIC (CM)			ENGLISH (IN)			METRIC	ENGLISH	METRIC	ENGLISH
		L	W	H	L	W	H	KG	LBS	KG	LBS
GR801	CHESS PRESS	130	166	171	51	65	67	166	364	99.8	220
GR802	SEATED ROW	138	135	130	54	53	51	156	342	99.8	220
GR803	SHOULDER PRESS	140	150	148	55	59	58	151	331	99.8	220
GR804	INCLINE CHEST PRESS	110	188	67	43	74	66	156	342	99.8	220
GR805	WIDE CHEST PRESS	138	168	178	54	66	70	171	375	99.8	220
GR806	PULL DOWN	178	125	196	70	49	77	171	375	99.8	220
GR807	LOW ROW	130	130	163	51	51	64	166	364	99.8	220
GR808	LEG PRESS	224	176	153	88	69	60	201	441	240	529
GR809	CALF	168	102	115	66	40	45	132	287	146	320
GR810	REAR KICK	135	127	163	53	50	64	132	287	146	320
GR804	ISOLATED LEG PRESS	221	161	183	87	63	72	356	783		
GR1806	SUPER SQUAT	204	135	125	80	53	49	163	358		
FL1811	ADJUSTABLE HACK SQUAT	199	158	133	78	62	52	275	606		
FL1834	BELT SQUAT	168	171	219	66	67	86	155	341		

<b>STRENGTH WARRANTY (NORTH AMERICA ONLY)</b>						<b>STRENGTH WARRANTY (NORTH AMERICA ONLY)</b>					
FRAME (NOT COATINGS)**		LIFETIME			OTHER ITEMS NOT SPECIFIED				3 YEARS		
WEIGHT STACKS		10 YEARS			LABOR				3 YEARS		
PULLEYS		10 YEARS			UPHOLSTERY / CABLES / SPRINGS / GRIPS				1 YEAR		
PIVOT BEARINGS		10 YEARS			ACCESSORIES				6 MONTHS		

\* DIMENSIONS LISTED ARE MAXIMUM IN-USE DIMENSIONS

\*\* FRAME IS DEFINED AS THE WELDED-METAL BASE OF THE UNIT AND DOES NOT INCLUDE REMOVABLE PARTS

NOT: ALL SPECIFICATIONS ARE SUBJECT TO CHANGE WITHOUT NOTICE. ACTUAL PRODUCTS MAY DIFFER FROM THOSE PICTURED IN THIS CATALOG

## STACKED SERIES

CODE	PRODUCT NAME	PRODUCT DIMENSIONS*						PRODUCT WEIGHT		WEIGHT STACK	
		METRIC (CM)			ENGLISH (IN)			METRIC	ENGLISH	METRIC	ENGLISH
		L	W	H	L	W	H	KG	LBS	KG	LBS
FL1862	BELT SQUAT	163	191	193	64	75	76	345	760		
FL1844	HIP THRUST	138	138	140	54	54	33	83	181		
CF8137	PENDULUM SQUAT	173	87	239	68	34	94	214	470		
CF8138	HIP PRESS	143	102	115	56	40	45	123	270		
<b>STRENGTH WARRANTY (NORTH AMERICA ONLY)</b>						<b>STRENGTH WARRANTY (NORTH AMERICA ONLY)</b>					
FRAME (NOT COATINGS)**				LIFETIME		OTHER ITEMS NOT SPECIFIED				3 YEARS	
WEIGHT STACKS				10 YEARS		LABOR				3 YEARS	
PULLEYS				10 YEARS		UPHOLSTERY / CABLES / SPRINGS / GRIPS				1 YEAR	
PIVOT BEARINGS				10 YEARS		ACCESSORIES				6 MONTHS	

\* DIMENSIONS LISTED ARE MAXIMUM IN-USE DIMENSIONS

\*\* FRAME IS DEFINED AS THE WELDED-METAL BASE OF THE UNIT AND DOES NOT INCLUDE REMOVABLE PARTS

NOT: ALL SPECIFICATIONS ARE SUBJECT TO CHANGE WITHOUT NOTICE. ACTUAL PRODUCTS MAY DIFFER FROM THOSE PICTURED IN THIS CATALOG

## LIXX RACK

CODE	PRODUCT NAME	PRODUCT DIMENSIONS*						PRODUCT WEIGHT		WEIGHT STACK	
		METRIC (CM)			ENGLISH (IN)			METRIC	ENGLISH	METRIC	ENGLISH
		L	W	H	L	W	H	KG	LBS	KG	LBS
VFCR1701A	SINGLE BAY	127	92	239	50	36	94	230	505		
VFCR1701B	SMITH MACHINE	208	159	239	82	63	95	258	567		
VFCR1701C	CABLE CROSS	259	105	239	102	42	95	476	1048		
VFCR1701D	STORAGE RACK	259	105	239	102	42	95	476	1048		
VFCR1702B	FULL LIXX RACK	646	161	239	254	63	94	1009	2223		-
<b>STRENGTH WARRANTY (NORTH AMERICA ONLY)</b>						<b>STRENGTH WARRANTY (NORTH AMERICA ONLY)</b>					
FRAME (NOT COATINGS)**				LIFETIME		OTHER ITEMS NOT SPECIFIED				3 YEARS	
WEIGHT STACKS				10 YEARS		LABOR				3 YEARS	
PULLEYS				10 YEARS		UPHOLSTERY / CABLES / SPRINGS / GRIPS				1 YEAR	
PIVOT BEARINGS				10 YEARS		ACCESSORIES				6 MONTHS	

\* DIMENSIONS LISTED ARE MAXIMUM IN-USE DIMENSIONS

\*\* FRAME IS DEFINED AS THE WELDED-METAL BASE OF THE UNIT AND DOES NOT INCLUDE REMOVABLE PARTS

NOT: ALL SPECIFICATIONS ARE SUBJECT TO CHANGE WITHOUT NOTICE. ACTUAL PRODUCTS MAY DIFFER FROM THOSE PICTURED IN THIS CATALOG

## SMART SLED

CODE	PRODUCT NAME	PRODUCT DIMENSIONS*						PRODUCT WEIGHT		WEIGHT STACK	
		METRIC (CM)			ENGLISH (IN)			METRIC	ENGLISH	METRIC	ENGLISH
		L	W	H	L	W	H	KG	LBS	KG	LBS
	SMART SLED	64	102	79	25	40	31	270	595	114	250
<b>STRENGTH WARRANTY (NORTH AMERICA ONLY)</b>						<b>STRENGTH WARRANTY (NORTH AMERICA ONLY)</b>					
FRAME (NOT COATINGS)**				LIFETIME		OTHER ITEMS NOT SPECIFIED				3 YEARS	
WEIGHT STACKS				10 YEARS		LABOR				3 YEARS	
PULLEYS				10 YEARS		UPHOLSTERY / CABLES / SPRINGS / GRIPS				1 YEAR	
PIVOT BEARINGS				10 YEARS		ACCESSORIES				6 MONTHS	

\* DIMENSIONS LISTED ARE MAXIMUM IN-USE DIMENSIONS

\*\* FRAME IS DEFINED AS THE WELDED-METAL BASE OF THE UNIT AND DOES NOT INCLUDE REMOVABLE PARTS

NOT: ALL SPECIFICATIONS ARE SUBJECT TO CHANGE WITHOUT NOTICE. ACTUAL PRODUCTS MAY DIFFER FROM THOSE PICTURED IN THIS CATALOG

